

02-03 2282



MODU **LED** VEDI-SEE-VOIR  
PAG. 12



Classe II a richiesta  
Es. Codice per CL. II 2282-02...30II  
Class II on request  
Ex. Code for CL. II 2282-02...30II  
Classe II en option  
Ex. de code pour CL. II 2282-02...30II

COD.	LAMP	V	W
2282-02...30	E27	250	75 max
2282-03...30			

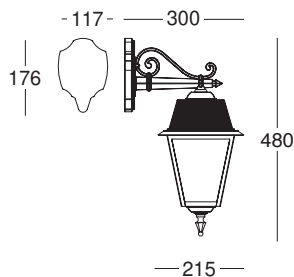

2282-02

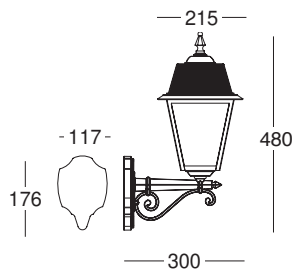

2282-03

# 02-03 2283-2255





 Classe II a richiesta  
 Es. Codice per CL. II 2255-02...30II  
 Class II on request  
 Ex. Code for CL. II 2255-02...30II  
 Classe II en option  
 Ex. de code pour CL. II 2255-02...30II

**MODU LED** VEDI-SEE-VOIR  
 PAG. 12

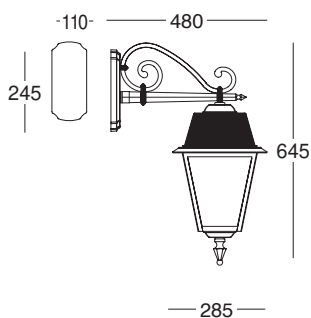

COD.	LAMP	V	W
2255-02...30			
2255-03...30			
2283-02...30	E27	250	75 max
2283-03...30			



2283-02

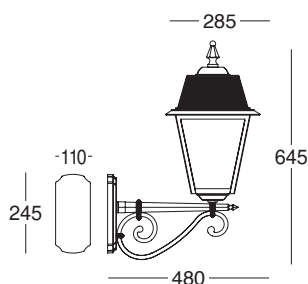

2283-03

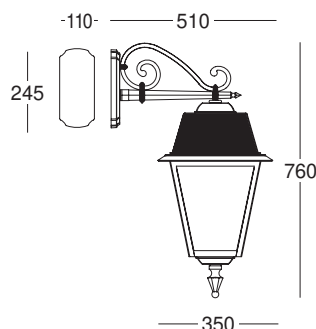

2255-02

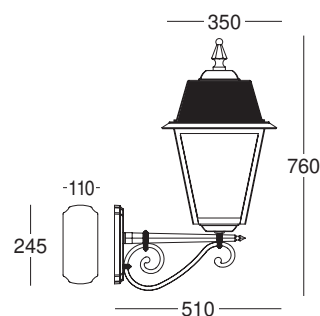

2255-03

01 2282-2283-2255





 Classe II a richiesta  
 Es. Codice per CL. II 2255-01...30II  
 Class II on request  
 Ex. Code for CL. II 2255-01...30II  
 Classe II en option  
 Ex. de code pour CL. II 2255-01...30II

**MODU LED** VEDI-SEE-VOIR  
 PAG. 12

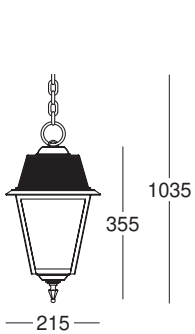

COD.	LAMP	V	W
2255-01...30			
2282-01...30	E27	250	75 max
2283-01...30			



2282-01

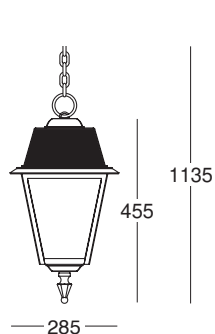

2283-01

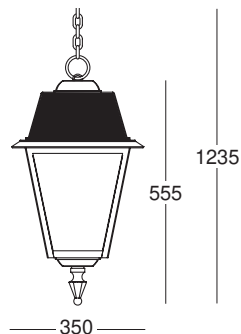

2255-01

# 04 2282-2283-2255

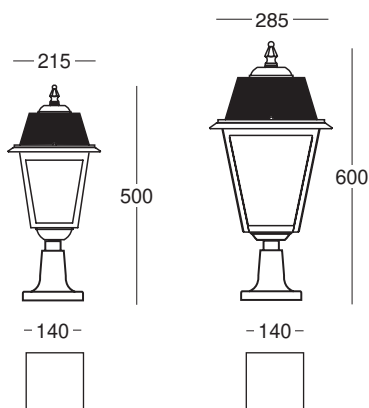

2282-04

2283-04

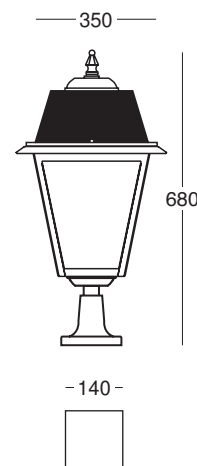

2255-04



Classe II a richiesta  
 Es. Codice per CL. II 2255-04...30II  
 Class II on request  
 Ex. Code for CL. II 2255-04...30II  
 Classe II en option  
 Ex. de code pour CL. II 2255-04...30II

MODU **LED** VEDI-SEE-VOIR  
 PAG. 12



COD.	LAMP	V	W
2255-04...30	E27	250	75 max
2282-04...30			
2283-04...30			

# 25 2282-2283-2255

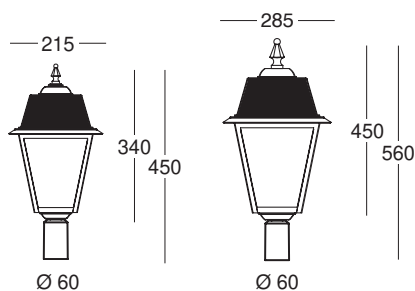

2282-25

2283-25

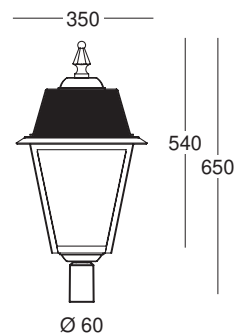

2255-25



Classe II a richiesta  
 Es. Codice per CL. II 2255-25...30II  
 Class II on request  
 Ex. Code for CL. II 2255-25...30II  
 Classe II en option  
 Ex. de code pour CL. II 2255-25...30II

MODU **LED** VEDI-SEE-VOIR  
 PAG. 12



COD.	LAMP	V	W
2255-25...30	E27	250	75 max
2282-25...30			
2283-25...30			

06-07 2282-2283

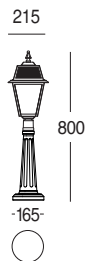

2282-05

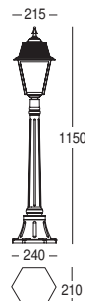

2282-06 \* KIT 9978-A

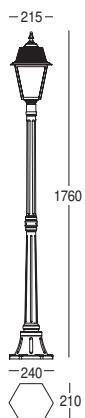

2282-07 \* KIT 9978-A

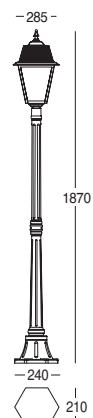

2283-07 \* KIT 9978-A

\* FISSAGGIO A TERRA PER PALI (OPZIONALI)  
GROUND FIXING FOR POLES (OPTIONAL)  
FIXATION AU SOL POUR POTEAUX (EN OPTION)

per base-for base-pour base  
240x210 mm

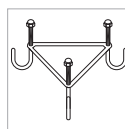

9978-A



Classe II a richiesta  
Es. Codice per CL. II 2282-06...30II  
Class II on request  
Ex. Code for CL. II 2282-06...30II  
Classe II en option  
Ex. de code pour CL. II 2282-06...30II

MODU **LED** VEDI-SEE-VOIR  
PAG. 12



COD.	LAMP	V	W
------	------	---	---

2282-05...30			
2282-06...30			
2282-07...30			
2283-07...30			

E27

250

75 max

# 08 2282-2283-2255

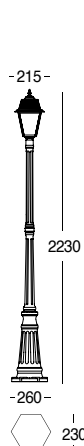

2282-08 \* KIT 9974-A

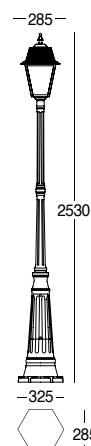

2283-08 \* KIT 9975-A

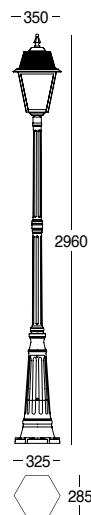

2255-08 \* KIT 9975-A

\* FISSAGGIO A TERRA PER PALI (OPZIONALI)  
GROUND FIXING FOR POLES (OPTIONAL)  
FIXATION AU SOL POUR POTEAUX (EN OPTION)

per base-for base-pour base  
260x230 mm

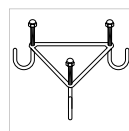

9974-A

per base-for base-pour base  
325x285 mm

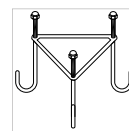

9975-A



Classe II a richiesta  
Es. Codice per CL. II 2255-08...30II  
Class II on request  
Ex. Code for CL. II 2255-08...30II  
Classe II en option  
Ex. de code pour CL. II 2255-08...30II

MODU **LED** VEDI-SEE-VOIR  
PAG. 12



COD.	LAMP	V	W
2255-08...30			
2282-08...30	E27	250	75 max
2283-08...30			

09 2282-2283-2255



2282-09 \* KIT 9974-A

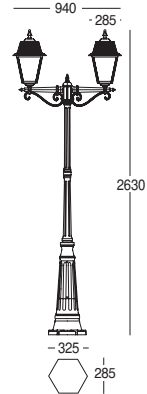

2283-09 \* KIT 9975-A

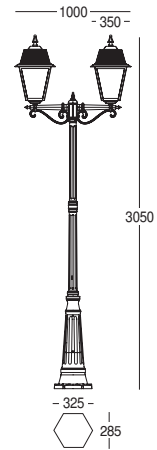

2255-09 \* KIT 9975-A

\* FISSAGGIO A TERRA PER PALI (OPZIONALI)  
GROUND FIXING FOR POLES (OPTIONAL)  
FIXATION AU SOL POUR POTEAUX (EN OPTION)

per base-for base-pour base  
260x230 mm

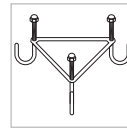

9974-A

per base-for base-pour base  
325x285 mm

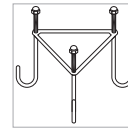

9975-A



Classe II a richiesta  
Es. Codice per CL. II 2255-09...30II  
Class II on request  
Ex. Code for CL. II 2255-09...30II  
Classe II en option  
Ex. de code pour CL. II 2255-09...30II

COD.

LAMP

V

W

2255-09...30  
2282-09...30  
2283-09...30

E27

250

75 max

MODU LED VEDI-SEE-VOIR  
PAG. 12



# 11 2282-2283-2255



2282-11 \* KIT 9974-A

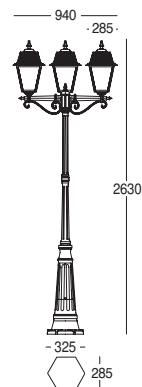

2283-11 \* KIT 9975-A

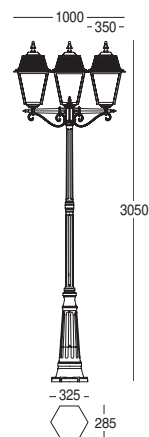

2255-11 \* KIT 9975-A

\* FISSAGGIO A TERRA PER PALI (OPZIONALI)  
GROUND FIXING FOR POLES (OPTIONAL)  
FIXATION AU SOL POUR POTEAUX (EN OPTION)

per base-for base-pour base  
260x230 mm

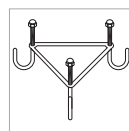

9974-A

per base-for base-pour base  
325x285 mm

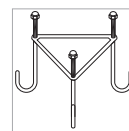

9975-A



Classe II a richiesta  
Es. Codice per CL. II 2255-11...30II  
Class II on request  
Ex. Code for CL. II 2255-11...30II  
Classe II en option  
Ex. de code pour CL. II 2255-11...30II

MODU **LED** VEDI-SEE-VOIR  
PAG. 12



COD.	LAMP	V	W
2255-11...30			
2282-11...30	E27	250	75 max
2283-11...30			



12-13 2283-2255





 Classe II a richiesta  
 Es. Codice per CL. II 2283-12...30II  
 Class II on request  
 Ex. Code for CL. II 2283-12...30II  
 Classe II en option  
 Ex. de code pour CL. II 2283-12...30II

**MODU LED** VEDI-SEE-VOIR  
 PAG. 12

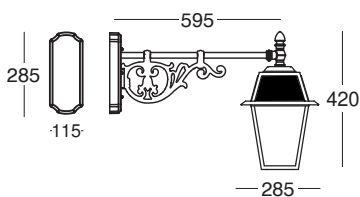

COD.	LAMP	V	W
2283-12...30	E27	250	75 max
2255-12...30			
2255-13...30			



2283-12

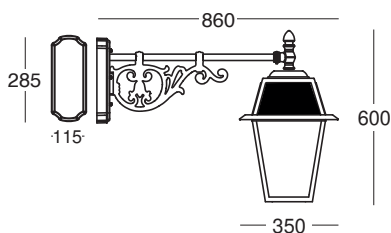

2255-12

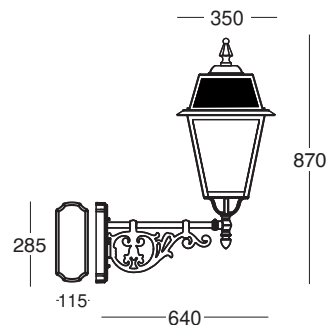

2255-13

# 14 2255



Classe II a richiesta  
 Es. Codice per CL. II 2255-14...30II  
 Class II on request  
 Ex. Code for CL. II 2255-14...30II  
 Classe II en option  
 Ex. de code pour CL. II 2255-14...30II

**MODU LED** VEDI-SEE-VOIR  
 PAG. 12 **D**

COD.	LAMP	V	W
2255-14...30	E27	250	75 max

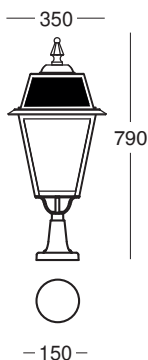

2255-14

# 17-18-19-21 2255

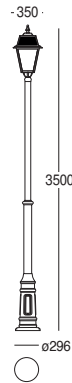

2255-17 \* KIT 9977-A

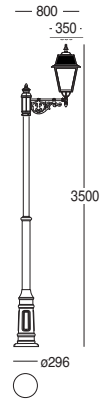

2255-18 \* KIT 9977-A

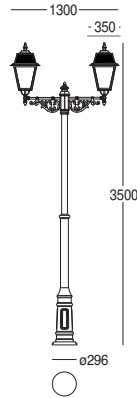

2255-19 \* KIT 9977-A

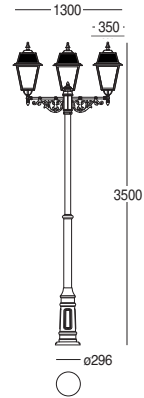

2255-21 \* KIT 9977-A

**\* FISSAGGIO A TERRA PER PALI (OPZIONALI)**  
**GROUND FIXING FOR POLES (OPTIONAL)**  
**FIXATION AU SOL POUR POTEAUX (EN OPTION)**

per base-for base-pour base  
 ø296 mm

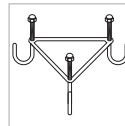

9977-A



Classe II a richiesta  
 Es. Codice per CL. II 2255-17...30II  
 Class II on request  
 Ex. Code for CL. II 2255-17...30II  
 Classe II en option  
 Ex. de code pour CL. II 2255-17...30II

**MODU LED** VEDI-SEE-VOIR  
 PAG. 12



COD.

LAMP

V

W

2255-17...30  
 2255-18...30  
 2255-19...30  
 2255-21...30

E27

250

75 max

# 27-28-29-31 2255

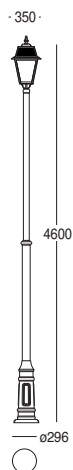

**2255-27** \* KIT 9977-A

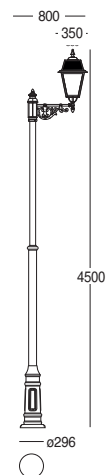

**2255-28** \* KIT 9977-A

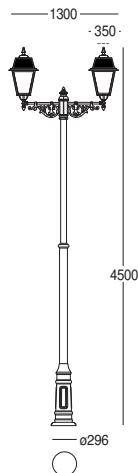

**2255-29** \* KIT 9977-A

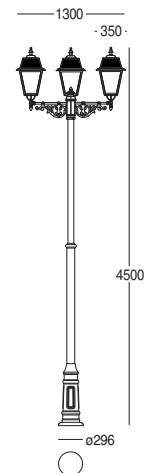

**2255-31** \* KIT 9977-A

**\* FISSAGGIO A TERRA PER PALI (OPZIONALI)  
GROUND FIXING FOR POLES (OPTIONAL)  
FIXATION AU SOL POUR POTEAUX (EN OPTION)**

per base-for base-pour base  
ø296 mm

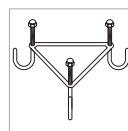

**9977-A**



Classe II a richiesta  
Es. Codice per CL. II 2255-27...30II  
Class II on request  
Ex. Code for CL. II 2255-27...30II  
Classe II en option  
Ex. de code pour CL. II 2255-27...30II

COD.

LAMP

V

W

2255-27...30  
2255-28...30  
2255-29...30  
2255-31...30

E27

250

75 max

**MODU LED** VEDI-SEE-VOIR  
PAG. 12

