

NEWTON20 serie S-OTP

Armatura da arredo urbano per illuminazione di parchi, viali, giardini, strade urbane, pontili, piazze, parcheggi, vie pedonabili e ciclopedonali.



Newton20 TPL small-medium

STANDARD				A RICHIESTA				
220-240V 50-60Hz	CCT 4000K	CRI 70+	IP 66	ECG CC	ECG DALI	MV	NEMA SOCKET	ZHAGA
IK10 CORPO	IK08 VETRO	ECG 1-10V		2200K 6000K		ONDE RADIO	ONDE CONV.	 LUMEFI

STREET

URBAN

INDUSTRIAL

FLOODLIGHT

GALLERY

KIT RETROFIT

SOLAR

CARATTERISTICHE PRINCIPALI

Corpo in pressofusione di alluminio verniciato;
 Ottica: lenti secondarie tipo S-OTP multilayer;
 Efficienza sorgente LED >230lm/W Ta 25°C Tj 25°C;
 Temperatura di colore sorgente LED: 4000K/3000K
 5700K (2200K/2700K/5000K/6000K su richiesta);
 Schermo di protezione in vetro piano temperato;
 CRI ≥70 (CRI ≥ 80, CRI ≥ 90 su richiesta);
 Grado di protezione IP66;
 Sezionatore automatico di linea;
 Schermo di protezione in vetro piano temperato;
 Resistenza meccanica IK08 (diffusore) IK10 (corpo);
 Classe di isolamento: I - II;
 Alimentazione: 220÷240V - 50/60Hz;
 Fattore di potenza: > 0.90;
 Protezione sovratensioni fino a 6KV (fino a 10KV / fino
 a 20KV su richiesta);
 Verniciatura RAL 7024;
 Montaggio **TPL** : laterale con braccetto regolabile

DIMENSIONI

Newton20 TPL small: Diam. 380mm;
 Potenze: da 20 a 60W
Newton20 TPL medium: Diam. 520mm;
 Potenze: da 70 a 90W
 Altre potenze su richiesta

OTTICA S-OTP

ST : Ottica stradale
RT : Ottica rotosimmetrica
CP : Ottica ciclopedonale
AS : Ottica asimmetrica
AP : Attraversamento pedonale
 Altre distribuzioni fotometriche su richiesta.

NORME

CEI/EN 60598-1; CEI/EN 60598-2-3;
CEI/EN 62471 (ESETE RG0);
CEI/EN 62031; 2014/30/CE;

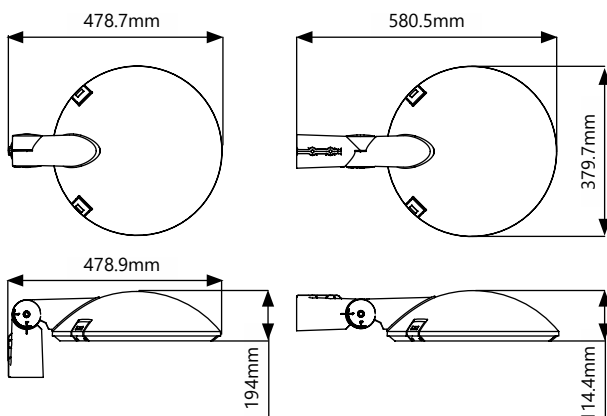

▶ Massima superficie esposta al vento : 0.114mq
 Peso : 8.00Kg

Dimensioni : NEWTON20 TPL SMALL - Attacco cimapalo laterale

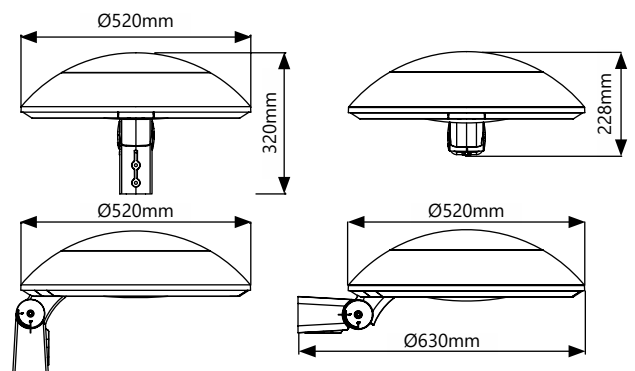

▶ Massima superficie esposta al vento : 0.213mq
 Peso : 11.00Kg

Dimensioni : NEWTON20 TPL MEDIUM - Attacco cimapalo laterale



ESEMPIO CODICE PRODOTTO	W	CRI	CCT	OTTICA S-OTP	DALI	1-10V	LUMEFI	MV	SMART CONTROL SYSTEM	CLASSE
CODICE BASE	(A)	(B)	(C)	(D)	(E)	(F)	(G)	(H)	(I)	(L)
NW20 TPL SMALL	30W	CRI 70	4000K	STRADALE	DALI	-	-	-	-	CLASSE II
NW20TPLS	30	7	40	ST	DA	-	-	-	-	02

NEWTON20 TOP POLE LATERALE SMALL

NW20 TPL S 4000 K	W	CRI	CCT	OTTICA S-OTP	FLUSSO LED	FLUSSO SISTEMA	DALI	1-10V	LUMEFI	MV	SMART CONTROL SYSTEM	CLASSE
CODICE BASE	(A)	(B)	(C)	(D)			(E)	(F)	(G)	(H)	(I)	(L)
NW20TPLS20-740	20	7	40	ST-RT-CP-AP-AS	4.600	3.100	DA	10V	LF	MV	NM-ZH-OR-OC	01 - 02
NW20TPLS30-740	30	7	40	ST-RT-CP-AP-AS	6.900	4.590	DA	10V	LF	MV	NM-ZH-OR-OC	01 - 02
NW20TPLS40-740	40	7	40	ST-RT-AP-AS	9.200	6.120	DA	10V	LF	MV	NM-ZH-OR-OC	01 - 02
NW20TPLS50-740	50	7	40	ST-RT-AP-AS	11.500	7.550	DA	10V	LF	MV	NM-ZH-OR-OC	01 - 02
NW20TPLS60-740	60	7	40	ST-RT-AP-AS	13.800	9.300	DA	10V	LF	MV	NM-ZH-OR-OC	01 - 02
NW20TPLS20-840	20	8	40	ST-RT-CP-AP-AS	4.240	3.038	DA	10V	LF	MV	NM-ZH-OR-OC	01 - 02
NW20TPLS30-840	30	8	40	ST-RT-CP-AP-AS	6.360	4.498	DA	10V	LF	MV	NM-ZH-OR-OC	01 - 02
NW20TPLS40-840	40	8	40	ST-RT-AP-AS	8.480	5.998	DA	10V	LF	MV	NM-ZH-OR-OC	01 - 02
NW20TPLS50-840	50	8	40	ST-RT-AP-AS	10.600	7.399	DA	10V	LF	MV	NM-ZH-OR-OC	01 - 02
NW20TPLS60-840	60	8	40	ST-RT-AP-AS	12.720	9.114	DA	10V	LF	MV	NM-ZH-OR-OC	01 - 02

NW20 TPL S 3000 K	W	CRI	CCT	OTTICA S-OTP	FLUSSO LED	FLUSSO SISTEMA	DALI	1-10V	LUMEFI	MV	SMART CONTROL SYSTEM	CLASSE
CODICE BASE	(A)	(B)	(C)	(D)			(E)	(F)	(G)	(H)	(I)	(L)
NW20TPLS20-730	20	7	30	ST-RT-CP-AP-AS	4.540	2.976	DA	10V	LF	MV	NM-ZH-OR-OC	01 - 02
NW20TPLS30-730	30	7	30	ST-RT-CP-AP-AS	6.810	4.406	DA	10V	LF	MV	NM-ZH-OR-OC	01 - 02
NW20TPLS40-730	40	7	30	ST-RT-AP-AS	9.080	5.875	DA	10V	LF	MV	NM-ZH-OR-OC	01 - 02
NW20TPLS50-730	50	7	30	ST-RT-AP-AS	11.350	7.248	DA	10V	LF	MV	NM-ZH-OR-OC	01 - 02
NW20TPLS60-730	60	7	30	ST-RT-AP-AS	13.620	8.928	DA	10V	LF	MV	NM-ZH-OR-OC	01 - 02
NW20TPLS20-830	20	8	30	ST-RT-CP-AP-AS	4.080	2.916	DA	10V	LF	MV	NM-ZH-OR-OC	01 - 02
NW20TPLS30-830	30	8	30	ST-RT-CP-AP-AS	6.120	4.318	DA	10V	LF	MV	NM-ZH-OR-OC	01 - 02
NW20TPLS40-830	40	8	30	ST-RT-AP-AS	8.160	5.758	DA	10V	LF	MV	NM-ZH-OR-OC	01 - 02
NW20TPLS50-830	50	8	30	ST-RT-AP-AS	10.200	7.103	DA	10V	LF	MV	NM-ZH-OR-OC	01 - 02
NW20TPLS60-830	60	8	30	ST-RT-AP-AS	12.240	8.749	DA	10V	LF	MV	NM-ZH-OR-OC	01 - 02

NEWTON20 TOP POLE LATERALE MEDIUM

NW20 TPL MD 4000 K	W	CRI	CCT	OTTICA S-OTP	FLUSSO LED	FLUSSO SISTEMA	DALI	1-10V	LUMEFI	MV	SMART CONTROL SYSTEM	CLASSE
CODICE BASE	(A)	(B)	(C)	(D)			(E)	(F)	(G)	(H)	(I)	(L)
NW20TPLMD70-740	70	7	40	ST-RT-AP-AS	16.100	10.850	DA	10V	LF	MV	NM-ZH-OR-OC	01 - 02
NW20TPLMD80-740	80	7	40	ST-AS	18.400	12.240	DA	10V	LF	MV	NM-ZH-OR-OC	01 - 02
NW20TPLMD90-740	90	7	40	ST-AS	20.700	13.770	DA	10V	LF	MV	NM-ZH-OR-OC	01 - 02
NW20TPLMD70-840	70	8	40	ST-RT-AP-AS	14.840	10.633	DA	10V	LF	MV	NM-ZH-OR-OC	01 - 02
NW20TPLMD80-840	80	8	40	ST-AS	16.960	11.995	DA	10V	LF	MV	NM-ZH-OR-OC	01 - 02
NW20TPLMD90-840	90	8	40	ST-AS	19.080	13.495	DA	10V	LF	MV	NM-ZH-OR-OC	01 - 02

NW20 TPL MD 3000 K	W	CRI	CCT	OTTICA	FLUSSO LED	FLUSSO SISTEMA	DALI	1-10V	LUMEFI	MV	SMART CONTROL SYSTEM	CLASSE
CODICE BASE	(A)	(B)	(C)	(D)			(E)	(F)	(G)	(H)	(I)	(L)
NW20TPLMD70-730	70	7	30	ST-RT-AP-AS	15.890	10.416	DA	10V	LF	MV	NM-ZH-OR-OC	01 - 02
NW20TPLMD80-730	80	7	30	ST-AS	18.160	11.750	DA	10V	LF	MV	NM-ZH-OR-OC	01 - 02
NW20TPLMD90-730	90	7	30	ST-AS	20.430	13.219	DA	10V	LF	MV	NM-ZH-OR-OC	01 - 02
NW20TPLMD70-830	70	8	30	ST-RT-AP-AS	14.280	10.208	DA	10V	LF	MV	NM-ZH-OR-OC	01 - 02
NW20TPLMD80-830	80	8	30	ST-AS	16.320	11.515	DA	10V	LF	MV	NM-ZH-OR-OC	01 - 02
NW20TPLMD90-830	90	8	30	ST-AS	18.360	12.955	DA	10V	LF	MV	NM-ZH-OR-OC	01 - 02

N.B: Al fine di favorire un costante aggiornamento dei propri prodotti, LUMEITALIA® informa che i valori di flusso e potenza dei LED sono soggetti a continue variazioni. LUMEITALIA® si riserva il diritto di apportare modifiche senza preavviso.

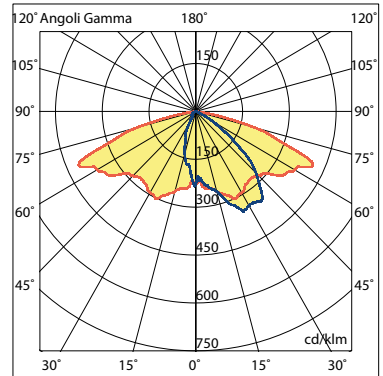
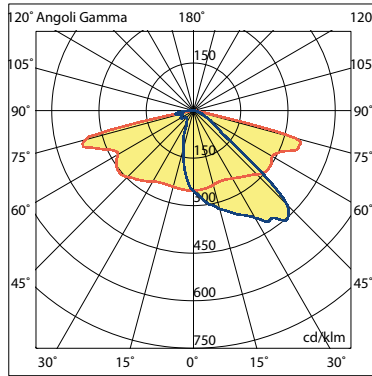
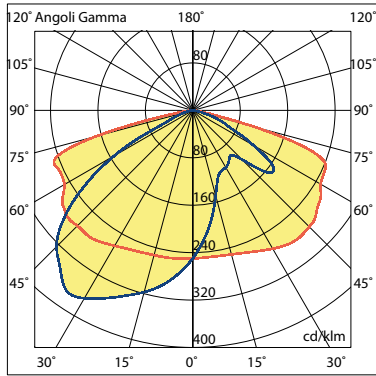
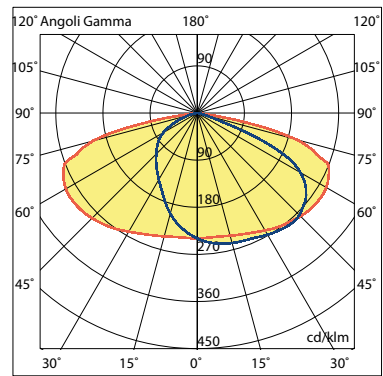
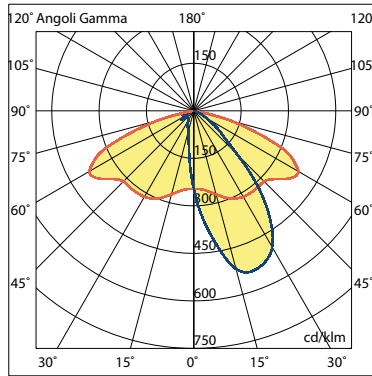
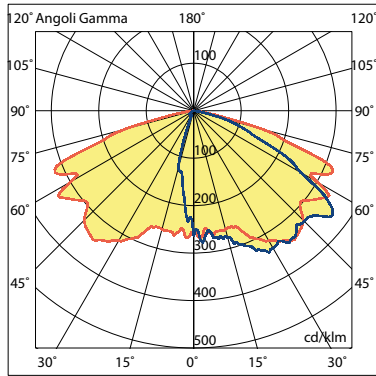
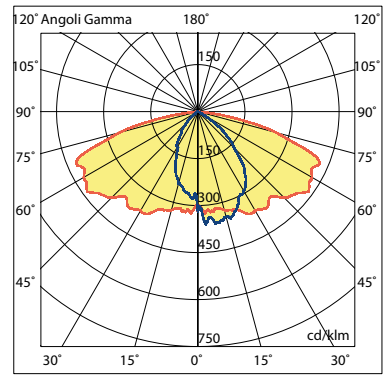
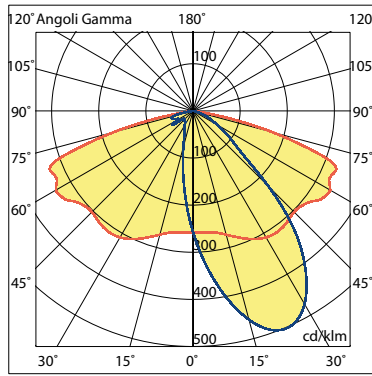
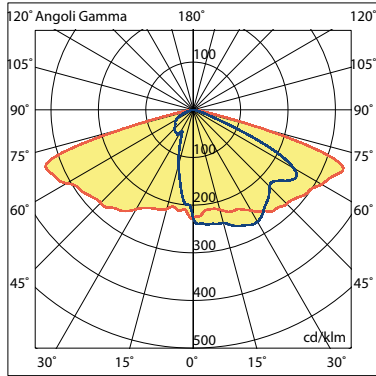
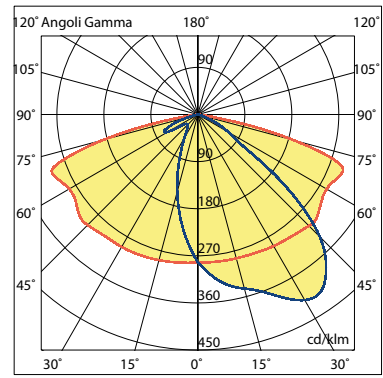
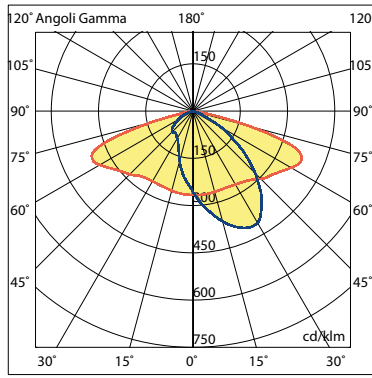
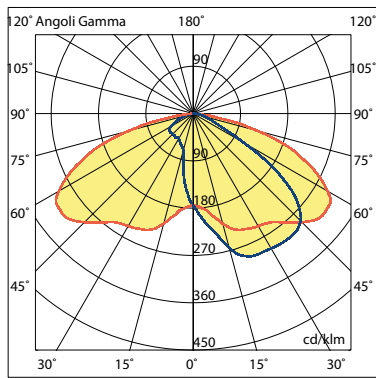

SPECIFICHE TECNICHE



DISTRIBUZIONE FOTOMETRICA _ ATTRAVERSAMENTO PEDONALE

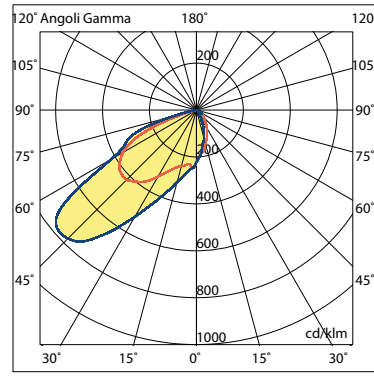
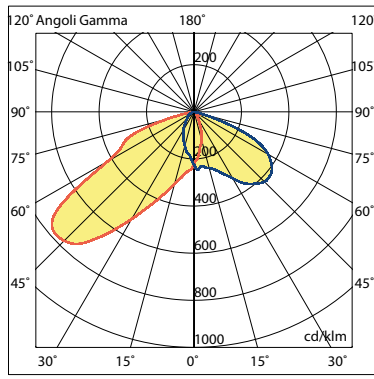
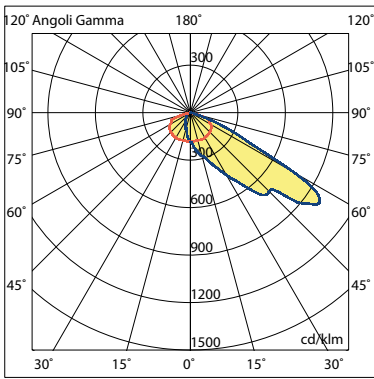

DISTRIBUZIONE FOTOMETRICA _ CICLOPEDONALE

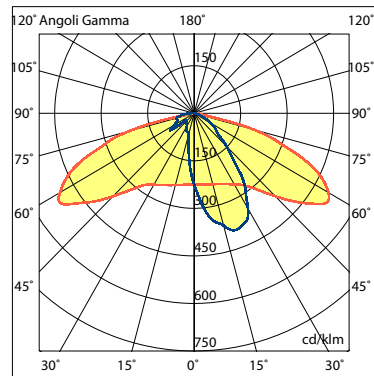
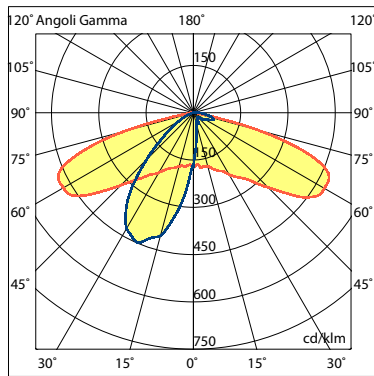
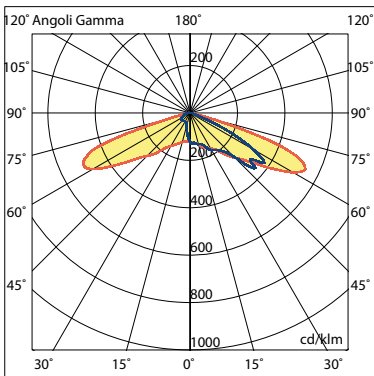

DISTRIBUZIONE _ ASIMMETRICA

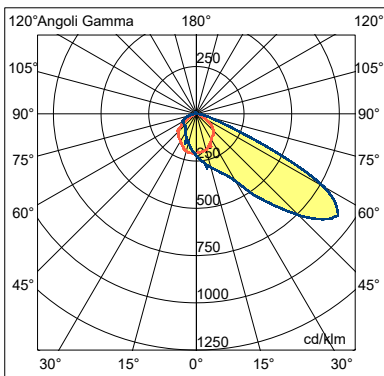

DISTRIBUZIONE _ ROTOSIMMETRICA

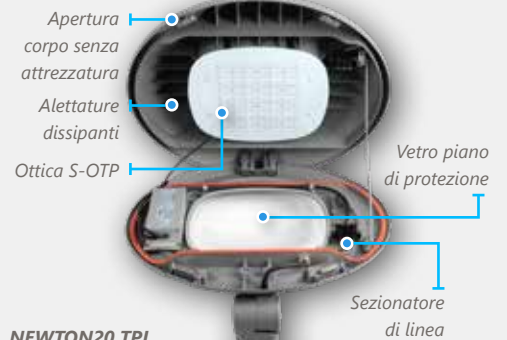
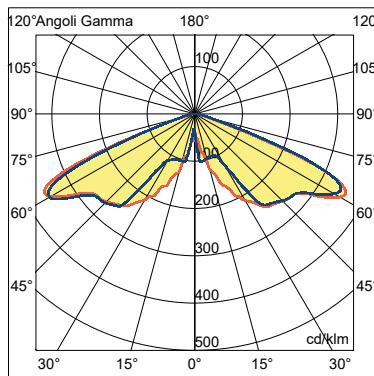

NEWTON20 TPL
medium

