

# Compatto P

Serie di paletti mono e bi-emissione ideati per l'illuminazione di vialetti, giardini disponibile in varie altezze. La costruzione del apparecchio in lega in alluminio ad alta resistenza alla ossidazione e sottoposto a trattamento con nano-bonderite protetto con verniciatura a polvere poliestere texturizzata, rendono il prodotto resistente agli agenti atmosferici ed ai raggi UV garantendone la massima protezione nel corso degli anni. Le guarnizioni in silicone assicurano la massima tenuta in tutte le condizioni operative e di temperatura. Il diffusore in vetro sodico calcico temprato e rigato garantisce una distribuzione ottimale della luce ed è rifinito con bordo serigrafato. La viteria è completamente in acciaio inossidabile.

*Series of bollards mono and bi-emission designed for lighting pathways, driveways available in various heights. The body is constructed of high oxidation resistant aluminum alloy which is subjected to nano-bonderite treatment and finished with texturized polyester powder paint, making the product resistant to atmospheric agents and UV rays, guaranteeing maximum protection over the years. Silicone gaskets ensure maximum sealing in all operating and temperature conditions. The opal ribbed tempered sodium calcium glass diffuser ensures maximum light distribution and is finished with a silkscreen border. All the external screws are in stainless steel.*



CERTIFICAZIONI CERTIFICATION	CE ENEC UK
GRADO DI PROTEZIONE IP / IK RATING	IP 65 / IK 08 IP 65 / IK 08
CLASSE DI ISOLAMENTO CLASSIFICATION	classe I class I
DIMMERABILE DIMMABLE	versione dimmerabile disponibile su richiesta dimmable version available upon request
CORPO BODY	alluminio estruso EN AW-6060 T5 ad alta resistenza alla ossidazione extruded aluminum EN AW-6060 T5 high resistance to oxidation
DIFFUSORE DIFFUSER	vetro sodico lime temprato 5mm soda-lime tempered glass 5mm
RIFLETTORE REFLECTOR	lenti in PMMA PMMA lens
VITERIA ESTERNA EXTERNAL FIXINGS	inox A4-70 trattata in soluzione lubrificante idrorepellente con alto potere antiossidante stainless steel A4-70 treated with highly antioxidant water-repellent lubricating solution
GUARNIZIONI SEALING GASKET	silicone silicone
INGRESSO CAVO CABLE ENTRY	apparecchio fornito con cavo precablato H05RN-F fixture supplied with pre-wired cable H05RN-F
SORGENTE LUMINOSA LIGHT SOURCE	LED incluso LED integral
FINITURA FINISH	verniciatura in polveri poliestere ad alta resistenza ai raggi UV ed alla corrosione powder coating polyester high resistance to UV and oxidation



# Compatto P 1L

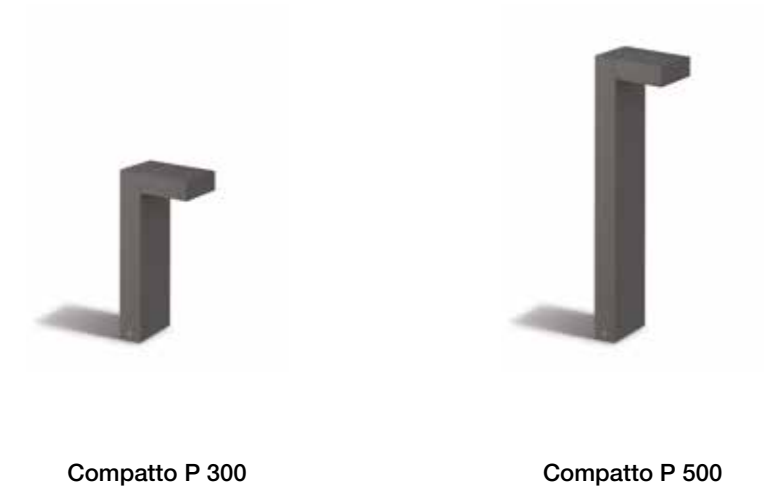
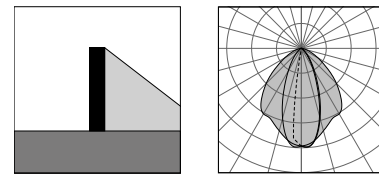

12W LED 3000K / 4000K  
1469lm - 1492lm  
220-240V 50/60hz  
alimentatore incluso *LED driver integral*

**GH1426**

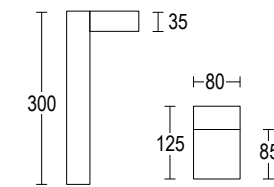

**GH1427**

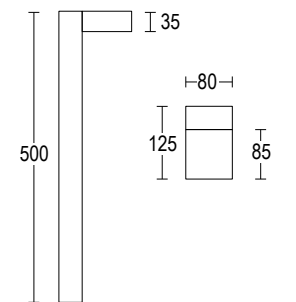

Vai alla pagina  
Web del prodotto  
*Go to the product Web page*

Grigio scuro opaco **05** ●  
*Dark grey matt*

Grigio chiaro **19** ●  
*Light grey*

Altre finiture disponibili sul sito web  
*Other finishes available on the website*

## ACCESSORI ACCESSORIES

**AC204**  
Connettore rapido IP68  
*IP68 fast connector*

**AC279**  
Connettore per cablaggio in cascata IP68  
*IP68 connector for the through wiring*

**AC274**  
Base di ancoraggio  
*Plated steel anchorage*



# Compatto P 2L



Compatto P 2L 300

Compatto P 2L 500

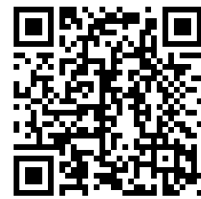

Vai alla pagina  
Web del prodotto  
Go to the product Web page

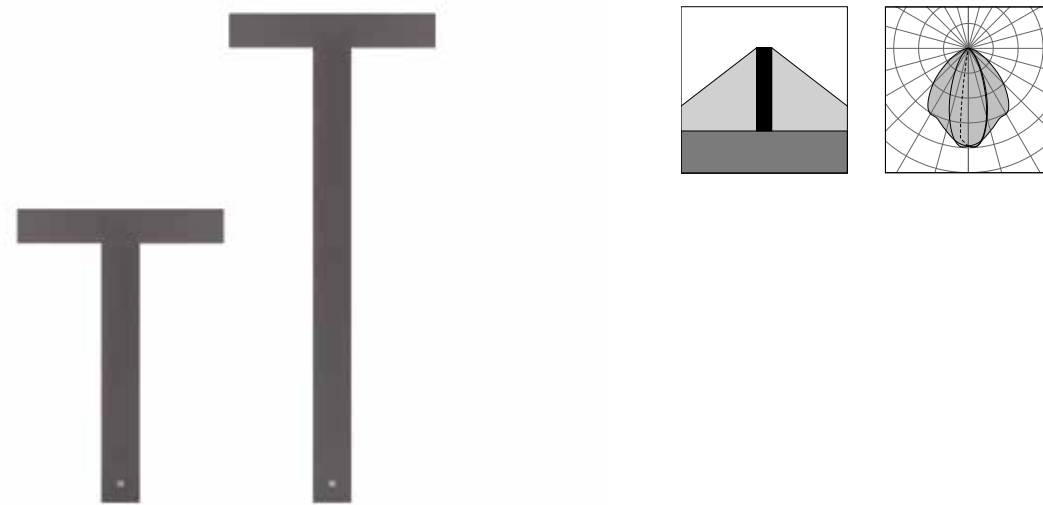

Grigio scuro opaco .05 ●  
Dark grey matt

Grigio chiaro .19 ●  
Light grey

Altre finiture disponibili sul sito web  
Other finishes available on the website

2x12W LED 3000K / 4000K  
2x1469lm - 1492lm  
220-240V 50/60hz  
alimentatore incluso LED driver integral

GH1462

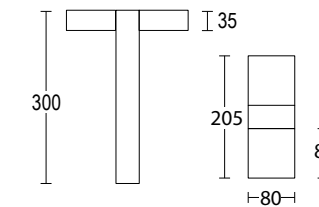

GH1463

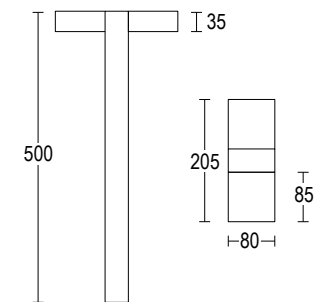

## ACCESSORI ACCESSORIES

**AC204**  
Connettore rapido IP68  
IP68 fast connector

**AC279**  
Connettore per cablaggio in cascata IP68  
IP68 connector for the through wiring

**AC274**  
Base di ancoraggio  
Plated steel anchorage