

Serie di apparecchi lineari da incassare a terreno dalla ridotta profondità di incasso e disponibili in due dimensioni e diverse lunghezze. Studiati per l'illuminazione di facciate, pareti e muri con effetto "wall wash" grazie ad ampia disponibilità di ottiche e potenze. La cornice esterna in acciaio inossidabile lo rende resistente al calpestio e gli conferisce un look raffinato. La costruzione del corpo ed i tappi di chiusura in lega in alluminio ad alta resistenza alla ossidazione sottoposti a trattamento con nano-bonderite protetti con verniciatura a polvere poliestere texturizzata, rendono il prodotto resistente agli agenti atmosferici ed ai raggi UV garantendone la massima protezione nel corso degli anni. Le guarnizioni in silicone assicurano la massima tenuta in tutte le condizioni operative e di temperatura. Il diffusore in vetro sodico calcico temprato iper trasparente, per garantire la massima trasmittanza della luce, è rifinito con bordo serigrafato. Il prodotto è equipaggiato con il sistema water-lock Ghidini che impedisce la suzione dell'umidità dal cavo di alimentazione dovuta all'alternarsi dei cicli di accensione e spegnimento. Il prodotto si installa con una cassaforma in polipropilene che previene il contatto dell'apparecchio con il terreno e consente di avere lo spazio necessario per il cablaggio. Il prodotto è calpestabile ed installabile in aree non consentite al traffico. Non adatto all'installazione in piscine o fontane.

*Series of linear luminaires to be recessed in-ground with reduced recess depth and various sizes and dimensions. Designed for the lighting of facades, walls with a "wall wash" effect thanks to the wide availability of optics and powers. The outer frame in stainless steel makes it resistant to trampling and gives it a refined look. The body and the side plugs are constructed of high oxidation resistant aluminum alloy which is subjected to nano-bonderite treatment and finished with textured polyester powder paint, making the product resistant to atmospheric agents and UV rays, guaranteeing maximum protection over the years. Silicone gaskets ensure maximum sealing in all operating and temperature conditions. The ultra transparent tempered sodium calcium glass diffuser ensures maximum light transmittance and is finished with a silkscreen border. The product is equipped with the Ghidini water-lock system which prevents condensation from the power cable due to the alternating on and off cycles. The product is installed with a polypropylene rough-in housing that prevents the contact of the fixture directly with the ground and allows the necessary space for wiring. The product can be walked on and installed in areas not permitted for traffic. Not suitable for installation in swimming pools or fountains.*



CERTIFICAZIONI CERTIFICATION	CE ENEC UK BSI IEC TUV SUD TUV SÜD
GRADO DI PROTEZIONE IP / IK RATING	Miniconfine IP 68 / IK 09; Confine IP 68 / IK 10 Miniconfine IP 68 / IK 09; Confine IP 68 / IK 10
CLASSE DI ISOLAMENTO CLASSIFICATION	classe I
DIMMERABILE DIMMABLE	versione dimmerabile DALI disponibile su richiesta dimnable DALI versione available upon request
CORPO BODY	acciaio inossidabile AISI 316L, Alluminio estruso EN AW-6060 T5, alluminio pressofuso EN AB 44100 resistente alla ossidazione Stainless steel AISI 316L, Extruded aluminum EN AW-6060 T5, Die-cast aluminum EN AB 44100 highly resistant to oxidation
CONTROCASSA ROUGH-IN HOUSING	polipropilene (PP) da ordinare separatamente polypropylene (PP) to be ordered separately
DIFFUSORE DIFFUSER	vetro sodico calcico temprato 8 mm soda-lime tempered glass 8 mm
VITERIA ESTERNA EXTERNAL FIXINGS	inox A4-70 trattata in soluzione lubrificante idrorepellente con alto potere antiossidante stainless steel A4-70 treated with highly antioxidant water-repellent lubricating solution
GUARNIZIONI SEALING GASKET	silicone silicone
CABLAGGIO WIRING	apparecchio fornito con 0,5 m di cavo H07RN8-F pre cablato con pressacavo in metallo M20 Ø7/13mm fixture supplied with pre wired cable 0,5 m long H07RN8-F with metal cable gland M20 Ø 7/13 mm
CABLAGGIO IN CASCATA WIRE THROUGH CONNECTION	possibile con accessorio possible with accessory
CALPESTABILE WALK OVER	carico massimo di pressione statica 500 Kg max static pressure load 500 Kg
DRENAGGIO DRAINAGE AREA	300mm di ghiaia o materiale drenante. In alternativa, sistema di tubazioni drenanti 300mm of gravel or draining material. Alternatively, draining piping system
SORGENTE LUMINOSA LIGHT SOURCE	Led incluso Led integral
FINITURA FINISH	verniciatura in polveri poliestere ad alta resistenza ai raggi UV ed alla corrosione - acciaio inox AISI 316L sp.2 mm powder coating polyester high resistance to UV and oxidation - 2 mm. thickness AISI 316L stainless steel



# MiniConfine



Vai alla pagina  
Web del prodotto  
Go to the product Web page

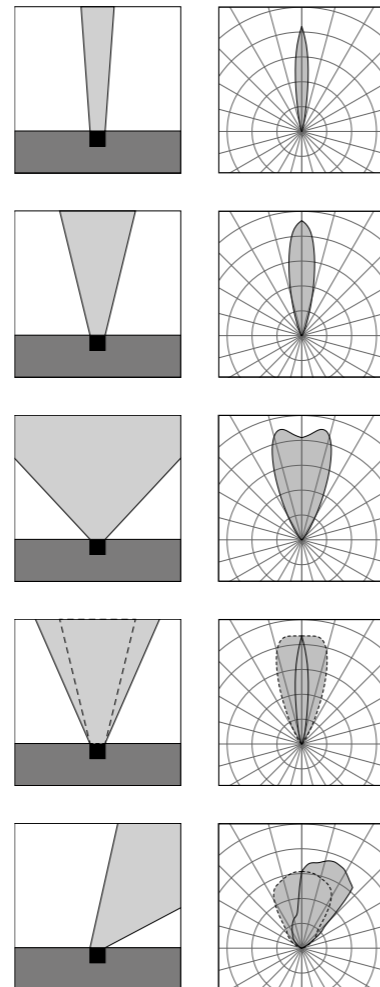

Acciaio inossidabile **15**   
Stainless Steel  
Altre finiture disponibili sul sito web  
Other finishes available on the website   

## MiniConfine 300

## MiniConfine 600

**MiniConfine 300**  
9W LED 3000K / 4000K  
876lm - 972lm  
12° / 25° / 50° / asymmetrical / elipsoidal  
220-240V 50/60hz  
alimentatore incluso LED driver integral

**MiniConfine 600**  
18W LED 3000K / 4000K  
1752lm - 1944lm  
12° / 25° / 50° / asymmetrical / elipsoidal  
220-240V 50/60hz  
alimentatore incluso LED driver integral

### GH1179

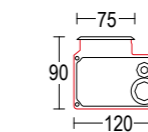
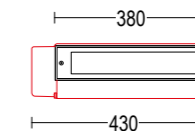

### GH1180

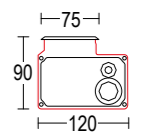
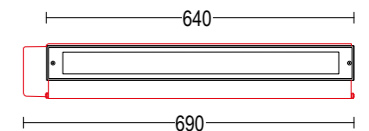

## ACCESSORI ACCESSORIES

 Controcassa  
Rough-in housing  
**AC603** Miniconfine GH1179  
**AC604** Miniconfine GH1180

 **AC204**  
Connettore rapido IP68  
IP68 fast connector

 **AC279**  
Connettore per cablaggio in cascata IP68  
IP68 connector for the through wiring



# MiniConfine

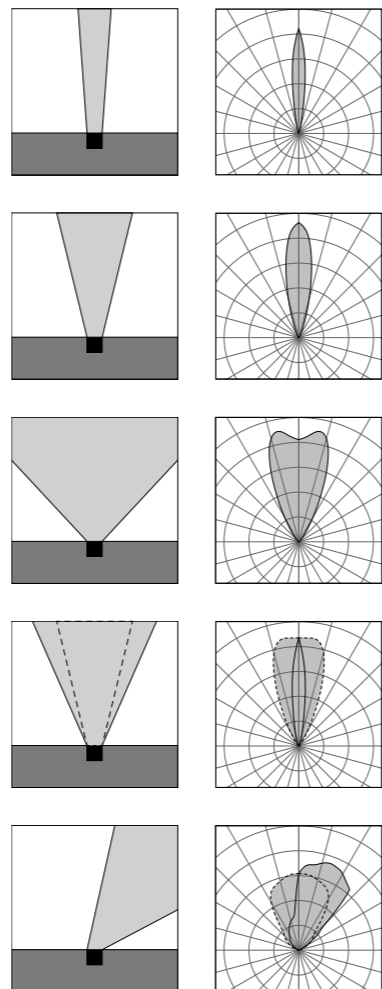

**MiniConfine 900**  
 27W LED 3000K / 4000K  
 2628lm - 2916lm  
 12° / 25° / 50° / asymmetrical / elipsoidale  
 220-240V 50/60hz  
 alimentatore incluso LED driver integral

**MiniConfine 1200**  
 36W LED 3000K / 4000K  
 3504lm - 3888lm  
 12° / 25° / 50° / asymmetrical / elipsoidale  
 220-240V 50/60hz  
 alimentatore incluso LED driver integral

MiniConfine 900

MiniConfine 1200

GH1181

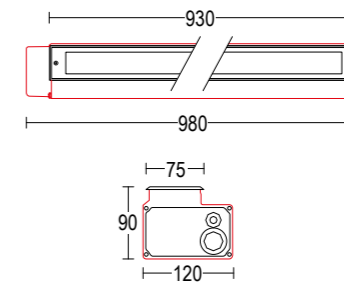

GH1182

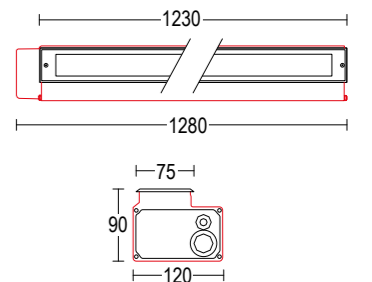

## ACCESSORI ACCESSORIES





Controcassa  
 Rough-in housing  
**AC605** Miniconfine GH1181  
**AC606** Miniconfine GH1182

**AC204**  
 Connettore rapido IP68  
 IP68 fast connector

**AC279**  
 Connettore per cablaggio in cascata IP68  
 IP68 connector for the through wiring



Vai alla pagina  
 Web del prodotto  
 Go to the product Web page

Acciaio inossidabile 15   
 Stainless Steel  
 Altre finiture disponibili sul sito web  
 Other finishes available on the website   

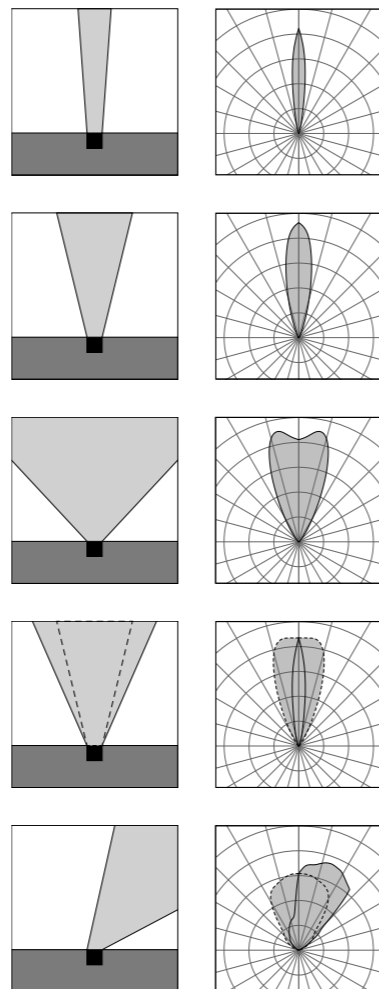

**Confine 300**  
 9W / 12,6W / 16 LED 3000K / 4000K  
 876lm - 1682lm  
 12° / 25° / 50° / asymmetrical / elipsoidale  
 220-240V 50/60hz  
 alimentatore incluso LED driver integral

**Confine 600**  
 18W / 25,2 / 32W LED 3000K / 4000K  
 1752lm - 3364lm  
 12° / 25° / 50° / asymmetrical / elipsoidale  
 220-240V 50/60hz  
 alimentatore incluso LED driver integral

Confine 300

Confine 600

GH1295

GH1296

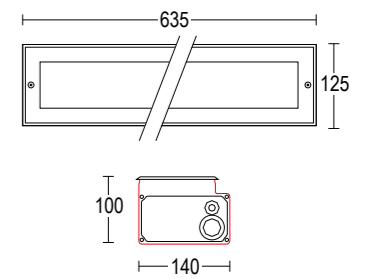
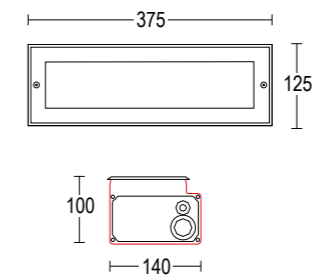

ACCESSORI  
 ACCESSORIES

Controcassa  
 Rough-in housing  
**AC280** Confine GH1295  
**AC281** Confine GH1296

**AC204**  
 Connettore rapido IP68  
 IP68 fast connector

**AC279**  
 Connettore per cablaggio in cascata IP68  
 IP68 connector for the through wiring



Vai alla pagina  
 Web del prodotto  
 Go to the product Web page

Acciaio inossidabile 15   
 Stainless Steel  
 Altre finiture disponibili sul sito web  
 Other finishes available on the website   







# Confine

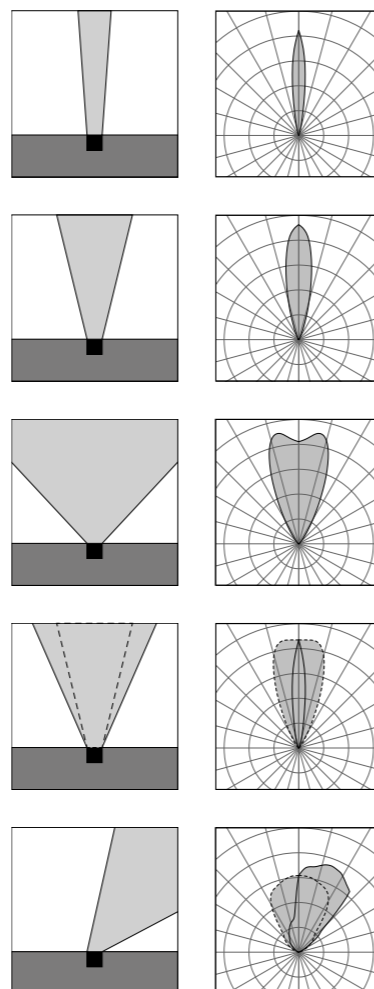

Vai alla pagina  
Web del prodotto  
Go to the product Web page



Acciaio inossidabile 15   
Stainless Steel  
Altre finiture disponibili sul sito web  
Other finishes available on the website   

## Confine 900

## Confine 1200

**Confine 900**  
27W / 37,8W / 48W LED 3000K / 4000K  
2628lm - 5046lm  
12° / 25° / 50° / asymmetrical / elipsoidal  
220-240V 50/60hz  
alimentatore incluso LED driver integral

**Confine 1200**  
36W / 50,4W / 64W LED 3000K / 4000K  
3504lm - 6728lm  
12° / 25° / 50° / asymmetrical / elipsoidal  
220-240V 50/60hz  
alimentatore incluso LED driver integral

### GH1297

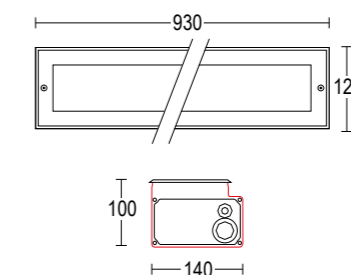

### GH1298

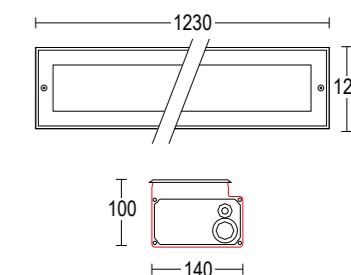

## ACCESSORI ACCESSORIES

 Controcassa  
Rough-in housing  
**AC282** Confine GH1297  
**AC283** Confine GH1298

 **AC204**  
Connettore rapido IP68  
IP68 fast connector

 **AC279**  
Connettore per cablaggio in cascata IP68  
IP68 connector for the through wiring